

YB5520

Product Guide

ASME B30.5
Imperial 85%



Features

- 18 t (20 USt) capacity
- 16,6 m (54.5 ft) four-section, four-plate full-power boom
- 9,07 t (10 USt) deck carrying ability
- Exclusive pivoting boom nose

GROVE YB5520

The YB5520 is a 18 t (20 USt) capacity carrydeck crane, offering a four-section 16,6 m (54.5 ft) boom with standard two-wheel drive/ four wheel steer capability. It also has a three-position pivoting boom head for low head room clearance and out and down outriggers that can be setup in several modes depending on jobsite requirements.

Features

> Reach and capacity to get the job done

The 5,64 m – 16,61 m (18.5 ft – 54.5 ft) four-section boom can be enhanced with optional boom extensions. The 4,6 m (15 ft) fixed swingaway extension offers a maximum tip height of 23,1 m (76 ft) while the 4,6 m – 7,6 m (15 ft – 25 ft) telescopic extension provides a maximum tip height of 26,2 m (86 ft). Both extensions can be offset 0°, -15°, and -30° via the pivoting boom nose.

> Steering

The YB5520 comes standard with three steering modes: front (two-wheel), four-wheel coordinated, and four-wheel crab steer with electronic self alignment. Operators can choose between modes using a three-position rocker switch located on dash panel.

> Outriggers

The YB5520 outriggers are two-position (0% and 100%) beam/jack style with inverted jack cylinders and pivoting pad.

> Pivoting boom nose

Three-position mechanically offset (0°, 40°, and 80°), lowers boom nose head height by 40,5 cm (1.33 ft) when pivoted fully forward. Negative pivoting of 0°, 15°, and 30° allows boom extension offset capability.

> Operator cab

Modern operator control layout with hydraulic proportional joystick controls, tilt steering wheel, and automotive dash panel gauges and indicator lights.



Jobsite benefits

> **Optimized productivity**

Hydraulic proportional joystick controls via load sensing piston pump hydraulics provide smooth and efficient operation. Optional RCL system with Work Area Definition System (WADS) and datalogger capability helps to improve operations.

> **Outstanding versatility and durability**

Split cab door with sliding glass window and tilt steering wheel for added operator comfort. Two-position out and down outriggers help to maximize load charts to meet space requirements. Full LED lighting package offers improved visibility and last longer than traditional light bulbs.

> **Piston pump hydraulics**

Provides excellent multi-function operation speeds. Large swing open access panel for easy serviceability.



Manitowoc Crane Care when you need it.
The assurance of the world's most advanced crane service and support to get you back to work fast.



Manitowoc Finance helps you get right to work generating profits for your business.
Financial tools that help you capitalize on opportunity with solutions that fit your needs.

Table of contents

Dimensions.....	5
Dimensions and weights.....	6
Range diagram - Imperial 85%.....	7
Load chart - Imperial 85%.....	8
Range diagram - Metric 85%.....	10
Load chart - Metric 85%.....	11
Rigging chart.....	13
Specifications.....	14
Symbols glossary.....	16

Dimensions

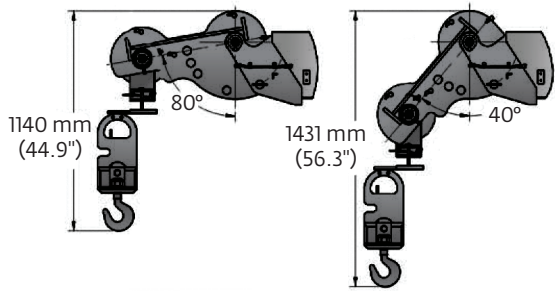

Dimensions					
	A	B	C	D	E
Two-wheel steer	3375 mm (11 ft 1 in)	6058 mm (19 ft 10.5 in)	6218 mm (20 ft 4.8 in)	6675 mm (21 ft 10.8 in)	7407 mm (24 ft 3.6 in)
Four-wheel steer	1722 mm (5 ft 8 in)	3841 mm (12 ft 7 in)	3993 mm (13 ft 1 in)	4481 mm (14 ft 8 in)	5380 mm (17 ft 8 in)

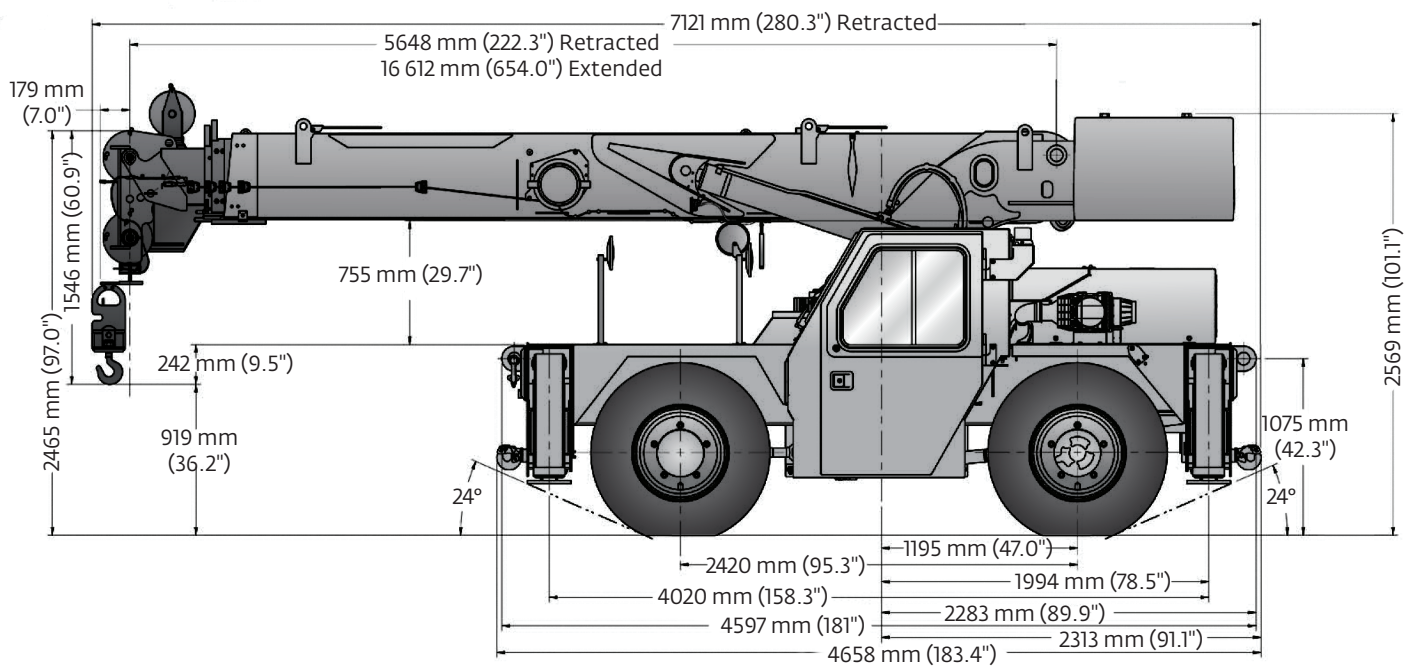
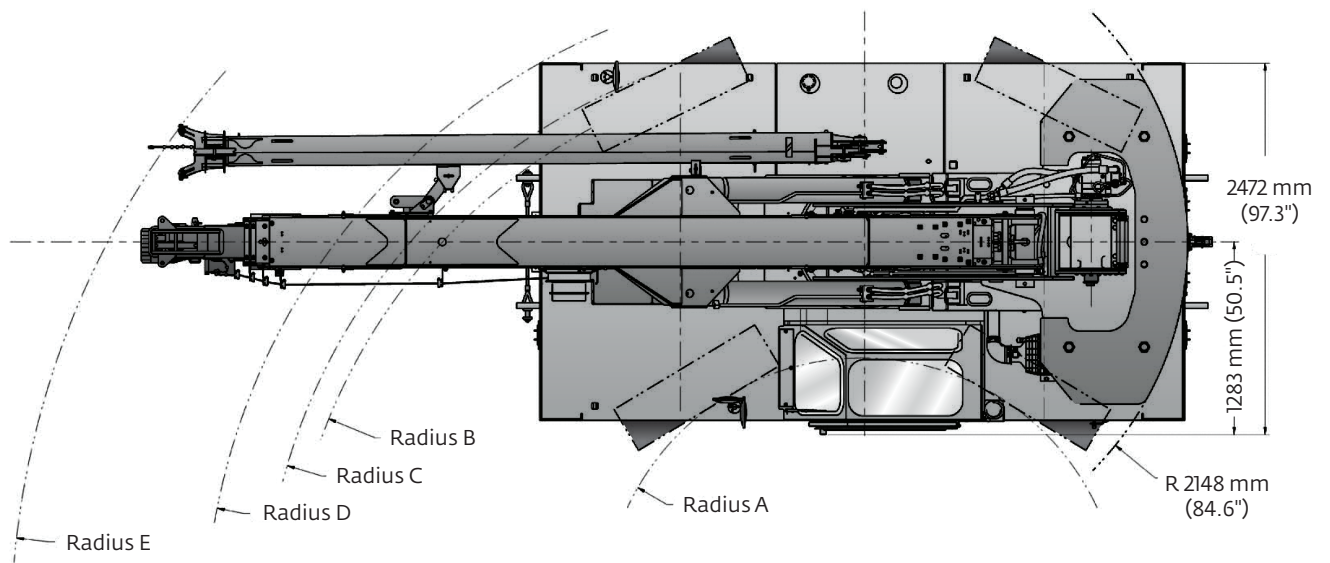

Dimensions and weights

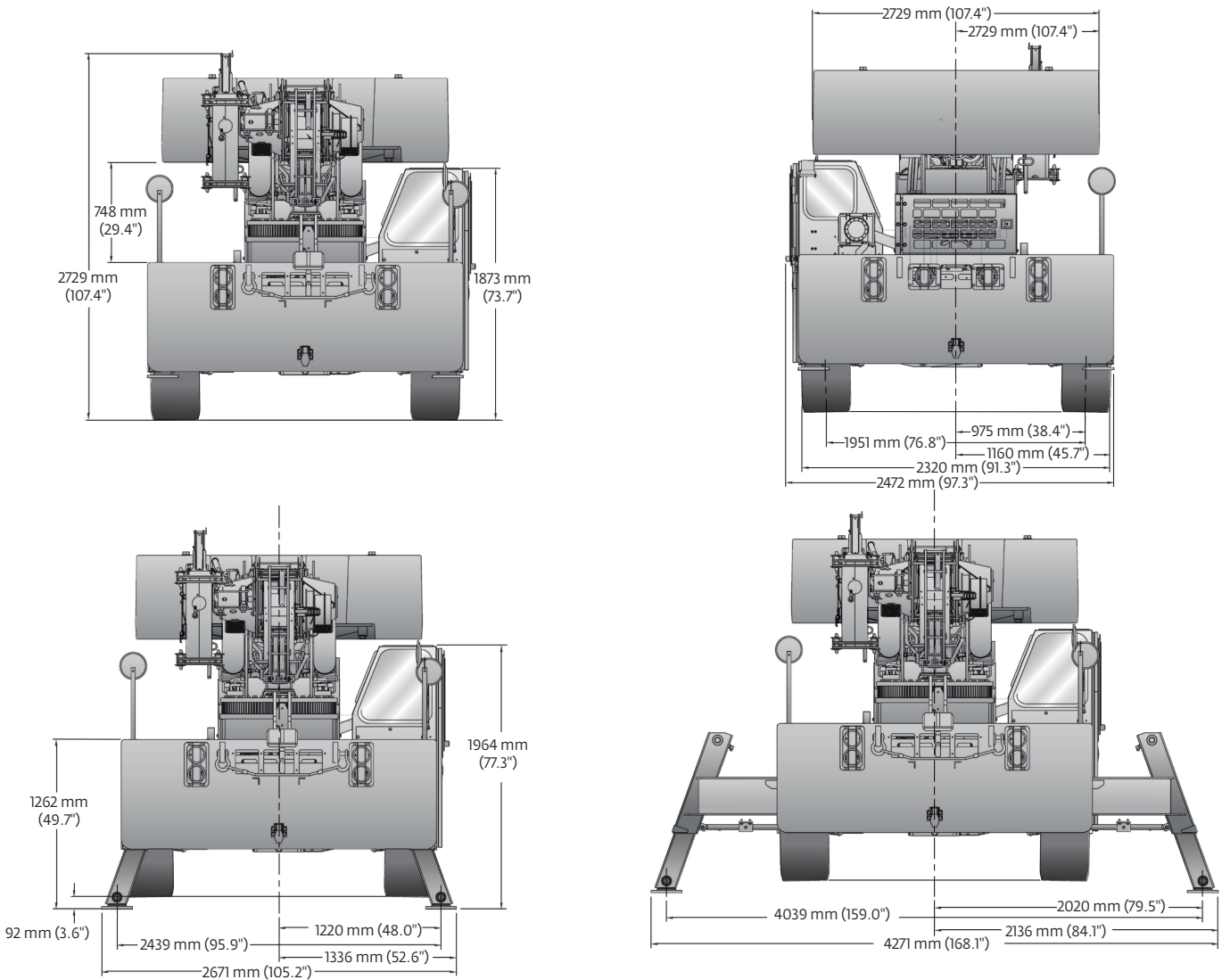

Weights

	GVW		Front		Rear	
	kg	lb	kg	lb	kg	lb
Basic machine: Including 16,6 m (54.5 ft) main boom, main hoist with 97,5 m (320 ft) of wire rope, 18 t (20 USt) hook block, full counterweight, Tier IV engine	16 220	35,758	6203	13,675	10 017	22,083
Add: 4,6 m (15 ft) fixed swingaway extension and extension carrier brackets and downhaul weight	199	438	323	713	-125	-275
Crane weight	16 419	36,196	6526	14,387	9893	21,809
Basic machine: Including 16,6 m (54.5 ft) main boom, main hoist with 97,5 m (320 ft) of wire rope, 18 t (20 USt) hook block, full counterweight, Tier IV engine	16 220	35,758	6203	13,675	10 017	22,083
Add: Enclosed cab, heater and glass	84,8	187	37,1	82	47,6	105
Crane weight	16 305	35,945	6240	13,757	10 064	22,188
Basic machine: Including 16,6 m (54.5 ft) main boom, main hoist with 97,5 m (320 ft) of wire rope, 18 t (20 USt) hook block, full counterweight, Tier IV engine	16 220	35,758	6203	13,675	10 017	22,083
Add: 4,6 m - 7,6 m (15 ft - 25 ft) telescopic swingaway extension and extension carrier brackets and downhaul weight	344	758	522	1151	-178	-393
Crane weight	16 564	36,516	6725	14,826	9839	21,690

Working range

Imperial 85%

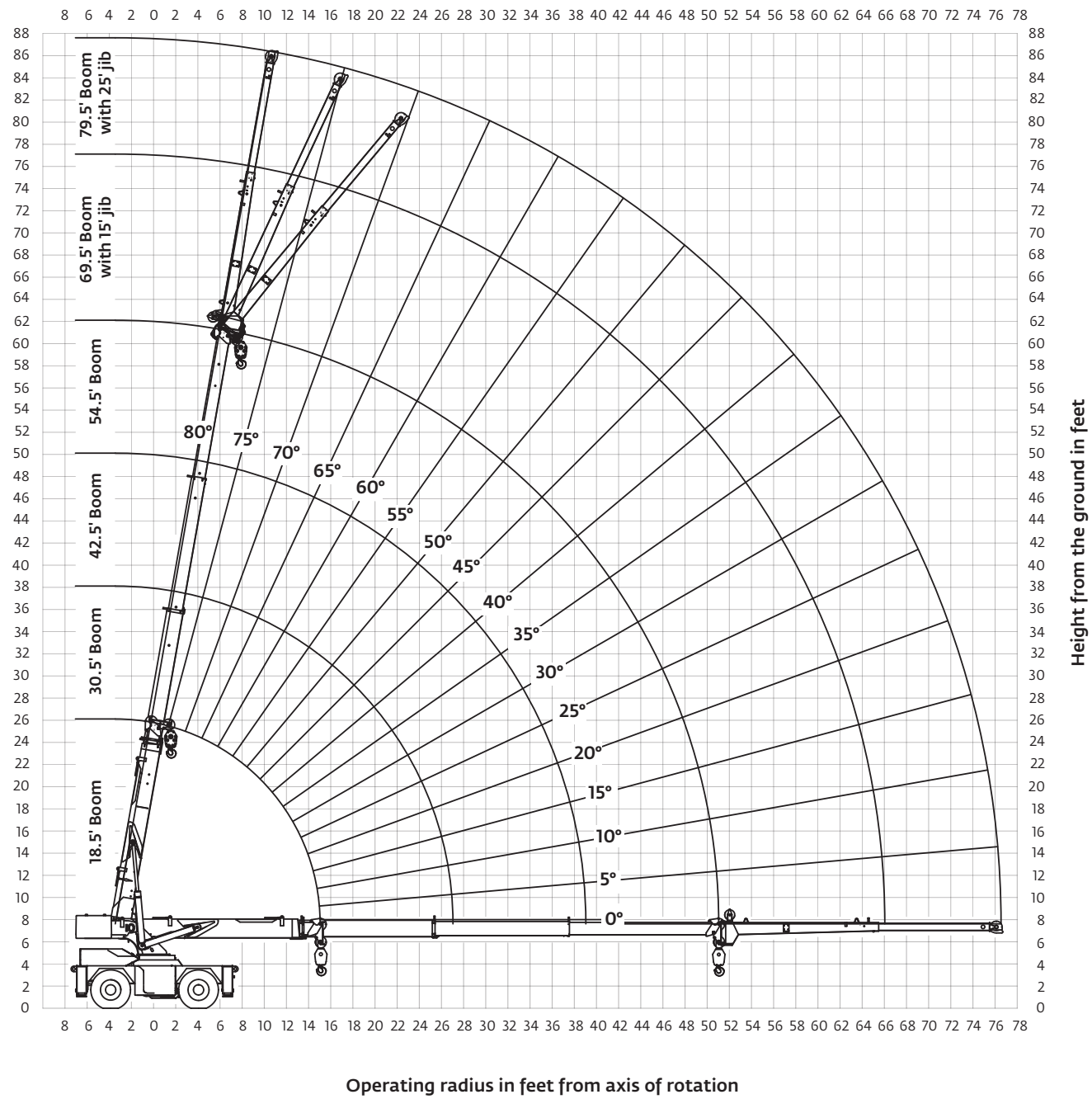

Operating radius in feet from axis of rotation

THIS CHART IS ONLY A GUIDE AND SHOULD NOT BE USED TO OPERATE THE CRANE.
 The individual crane's load chart, operating instructions and other instructional plates must be read and understood prior to operating the crane.

Load chart

Imperial 85%

MAIN BOOM LOAD RATINGS ON OUTRIGGERS								
Extended and Down 360° or Retracted and Down Front/Rear								
Radius (ft)	18.5 ft BOOM		30.5 ft BOOM		42.5 ft BOOM		54.5 ft BOOM	
	Boom Angle (deg)	Rated Load (lb)	Boom Angle (deg)	Rated Load (lb)	Boom Angle (deg)	Rated Load (lb)	Boom Angle (deg)	Rated Load (lb)
6	65	40000	75.5	24000	-	-	-	-
8	57.5	33850	71.5	24000	77.5	23650	-	-
10	49.5	30100	67.5	24000	75	21550	79	16800
12	39.5	26950	63	24000	72	19850	77	15350
14	25.5	23550	58.5	24000	69	18050	74.5	14100
15	0	18900	56.5	22500	67.5	17250	73.5	13500
16	-	-	54	21000	66	16550	72.5	13000
18	-	-	49	18450	63	15250	70	12100
20	-	-	43.5	16300	60	14250	68	11250
22	-	-	37	14150	56.5	13300	65.5	10550
24	-	-	29.5	12250	53	12200	63	9940
26	-	-	19	10700	49.5	10750	60.5	9380
27	-	-	0	10050	47.5	10150	59.5	9120
28	-	-	-	-	45.5	9600	58	8880
30	-	-	-	-	41.5	8620	55.5	8430
32	-	-	-	-	37	7790	53	8020
34	-	-	-	-	31.5	7090	50	7300
36	-	-	-	-	25	6470	47	6680
38	-	-	-	-	16	5920	44	6130
39	-	-	-	-	0	5680	42.5	5890
40	-	-	-	-	-	-	40.5	5650
42	-	-	-	-	-	-	37	5230
44	-	-	-	-	-	-	33	4850
46	-	-	-	-	-	-	28.5	4500
48	-	-	-	-	-	-	23	4180
51	-	-	-	-	-	-	0	3760

MAIN BOOM LOAD RATINGS ON OUTRIGGERS								
Retracted and Down 360°								
Radius (ft)	18.5 ft BOOM		30.5 ft BOOM		42.5 ft BOOM		54.5 ft BOOM	
	Boom Angle (deg)	Rated Load (lb)	Boom Angle (deg)	Rated Load (lb)	Boom Angle (deg)	Rated Load (lb)	Boom Angle (deg)	Rated Load (lb)
6	65	40000	75.5	24000	-	-	-	-
8	57.5	33850	71.5	24000	77.5	23650	-	-
10	49.5	24800	67.5	22950	75	21100	79	16800
12	39.5	17900	63	17950	72	16750	77	15350
14	25.5	13750	58.5	14500	69	13750	74.5	13000
15	0	12200	56.5	13000	67.5	12600	73.5	11950
16	-	-	54	11750	66	11500	72.5	11050
18	-	-	49	9780	63	9590	70	9560
20	-	-	43.5	8250	60	8150	68	8360
22	-	-	37	7040	56.5	7030	65.5	7360
24	-	-	29.5	6070	53	6120	63	6430
26	-	-	19	5270	49.5	5380	60.5	5680
27	-	-	0	4930	47.5	5050	59.5	5350
28	-	-	-	-	45.5	4750	58	5050
30	-	-	-	-	41.5	4230	55.5	4520
32	-	-	-	-	37	3780	53	4050
34	-	-	-	-	31.5	3380	50	3650
36	-	-	-	-	25	3040	47	3300
38	-	-	-	-	16	2740	44	2980
39	-	-	-	-	0	2600	42.5	2840
40	-	-	-	-	-	-	40.5	2710
42	-	-	-	-	-	-	37	2460
44	-	-	-	-	-	-	33	2240
46	-	-	-	-	-	-	28.5	2030
48	-	-	-	-	-	-	23	1840
51	-	-	-	-	-	-	0	1580

1) The rated loads are the maximum lift capacities as determined by operating radius, boom length and boom angle. The operating radius is the horizontal distance from a projection of the axis of rotation to the supporting surface, before loading, to the center of vertical hoist line or tackle with load applied.

2) The rated loads shown on outriggers do not exceed 85% of actual tipping. The rated loads shown on rubber do not exceed 75% of actual tipping. These ratings are based on freely suspended loads with the crane leveled, standing on a firm, uniform supporting surface. Practical working loads depend on supporting surface, operating radius and other factors affecting stability. Hazardous surroundings, climatic conditions, experience of personnel and proper training must all be taken into account by the operator.

3) The weights of all load handling devices such as hooks, hook blocks, slings, etc., except the hoist rope, shall be considered part of the load. See above.

4) Ratings on outriggers are for either outriggers fully extended and down or fully retracted and down. Ratings for outriggers fully retracted and down will apply for any intermediate outrigger setting.

5) Ratings on rubber depend on 12.00R20 tire capacity, condition of tires and proper inflation pressure (130 psi). Loads on rubber may be transported at a maximum speed of 2.5 mph on a smooth, hard, level surface with boom retracted to the shortest length possible and centered over front. For 360° ratings on rubber, rear axle oscillation locks must be in place. Do not use jib with crane on rubber.

6) For operating radius not shown, use load rating of next larger radius.

7) The maximum deck load only is 20,000 lb. Combined boom and deck loads are not permitted on rubber.

8) Do not induce any external side loads to boom or jib.

NOTES:
SHADED AREAS ARE GOVERNED BY STRUCTURAL STRENGTH, DO NOT RELY ON TIPPING.

OPERATION OF THIS EQUIPMENT IN EXCESS OF RATING CHARTS AND DISREGARD OF INSTRUCTIONS IS DANGEROUS AND VOIDS WARRANTY.

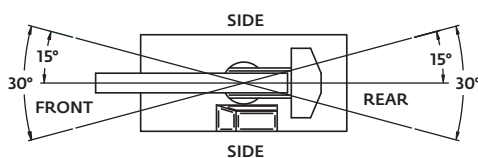

THIS CHART IS ONLY A GUIDE AND SHOULD NOT BE USED TO OPERATE THE CRANE.
The individual crane's load chart, operating instructions and other instructional plates must be read and understood prior to operating the crane.

Load chart

Imperial 85%

15 FT JIB CAPACITIES ON EXTENDED OUTRIGGERS					
Main Boom Angle (deg)	Jib Offset Angle				
	0 deg		15 deg		30 deg
	To 42.5 ft Main Boom	To 54.5 ft Main Boom	To 42.5 ft Main Boom	To 54.5 ft Main Boom	Any Boom Length
80	-	-	-	-	-
75	9300	6500	7400	5650	3500
70	8550	6100	6950	4350	2800
65	7950	6100	6500	3800	2350
60	7400	5650	5350	3500	2150
55	6950	4350	4550	2800	1900
50	6500	3800	4050	2350	1750
45	5350	3500	3450	2150	1670
40	4550	2800	3000	1900	1550
35	4050	2350	3150	1750	-
30	3450	2150	3000	1670	-
25	3300	1900	2800	1550	-
20	3150	1750	-	-	-
15	3000	1670	-	-	-
10	2800	1550	-	-	-
5	-	-	-	-	-
0	-	-	-	-	-

MAIN BOOM ON RUBBER		
Any Boom Length		
Radius (ft)	Front Rating (lb)	360° Rating (lb)
6	16000	15500
8	14100	13550
10	11250	10800
12	9860	8880
14	8700	7420
15	8190	6800
16	7720	6350
18	6890	5890
20	6180	5070
22	5570	4370
24	4990	3760
26	4460	3250
27	4220	3010
28	4100	2810
30	3680	2690
32	3300	2580
34	2950	2130
36	2640	1890
38	2350	1650
39	2220	1540
40	2160	1420
42	2110	1300
44	1910	1170
46	1720	1030
48	1550	900
51	1310	730

15 FT - 25 FT JIB CAPACITIES ON EXTENDED OUTRIGGERS										
Main Boom Angle (deg)	15 FT Length					25 FT Length				
	Jib Offset Angle									
	0 deg		15 deg		30 deg	0 deg		15 deg		30 deg
	To 42.5 ft Main Boom	To 54.5 ft Main Boom	To 42.5 ft Main Boom	To 54.5 ft Main Boom	Any Boom Length	To 42.5 ft Main Boom	To 54.5 ft Main Boom	To 42.5 ft Main Boom	To 54.5 ft Main Boom	Any Boom Length
80	8500	8550	5100	4770	3060	5830	5800	3710	3460	2200
75	6990	6650	4400	4100	2640	5120	4860	3190	2970	1890
70	5940	5580	3790	3540	2290	4330	4070	2740	2560	1630
65	5100	4770	3270	3060	1990	3710	3460	2350	2200	1410
60	4400	4100	2810	2640	1750	3190	2970	2020	1890	1230
55	3790	3540	2420	2290	1560	2740	2560	1730	1630	1090
50	3270	3060	2090	1990	1430	2350	2200	1480	1410	990
45	2810	2640	1830	1750	1370	2020	1890	1290	1230	950
40	2420	2290	1630	1560	1370	1730	1630	1140	1090	950
35	2090	1990	1490	1430	1280	1480	1410	1040	990	900
30	1830	1750	1440	1370	1250	1290	1230	1000	950	800
25	1630	1560	1440	1370	-	1140	1090	1000	950	-
20	1490	1430	1440	1280	-	1040	990	900	900	-
15	1440	1370	1250	1250	-	1000	950	800	800	-
10	1440	1370	-	-	-	1000	950	-	-	-
5	1440	1280	-	-	-	900	900	-	-	-
0	1250	1280	-	-	-	800	800	-	-	-

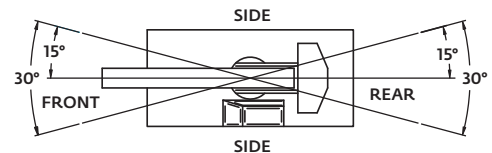

NOTES:
SHADED AREAS ARE GOVERNED BY STRUCTURAL STRENGTH, DO NOT RELY ON TIPPING.

OPERATION OF THIS EQUIPMENT IN EXCESS OF RATING CHARTS AND DISREGARD OF INSTRUCTIONS IS DANGEROUS AND VOIDS WARRANTY.

1) The rated loads are the maximum lift capacities as determined by operating radius, boom length and boom angle. The operating radius is the horizontal distance from a projection of the axis of rotation to the supporting surface, before loading, to the center of vertical hoist line or tackle with load applied.

2) The rated loads shown on outriggers do not exceed 85% of actual tipping. The rated loads shown on rubber do not exceed 75% of actual tipping. These ratings are based on freely suspended loads with the crane leveled, standing on a firm, uniform supporting surface. Practical working loads depend on supporting surface, operating radius and other factors affecting stability. Hazardous surroundings, climatic conditions, experience of personnel and proper training must all be taken into account by the operator.

3) The weights of all load handling devices such as hooks, hook blocks, slings, etc., except the hoist rope, shall be considered part of the load. See above.

4) Ratings on outriggers are for either outriggers fully extended and down or fully retracted and down. Ratings for outriggers fully retracted and down will apply for any intermediate outrigger setting.

5) Ratings on rubber depend on 12.00R20 tire capacity, condition of tires and proper inflation pressure (130 psi). Loads on rubber may be transported at a maximum speed of 2.5 mph on a smooth, hard, level surface with boom retracted to the shortest length possible and centered over front. For 360° ratings on rubber, rear axle oscillation locks must be in place. Do not use jib with crane on rubber.

6) For operating radius not shown, use load rating of next larger radius.

7) The maximum deck load only is 20,000 lb. Combined boom and deck loads are not permitted on rubber.

8) Do not induce any external side loads to boom or jib.

THIS CHART IS ONLY A GUIDE AND SHOULD NOT BE USED TO OPERATE THE CRANE.

The individual crane's load chart, operating instructions and other instructional plates must be read and understood prior to operating the crane.

Working range

Metric 85%

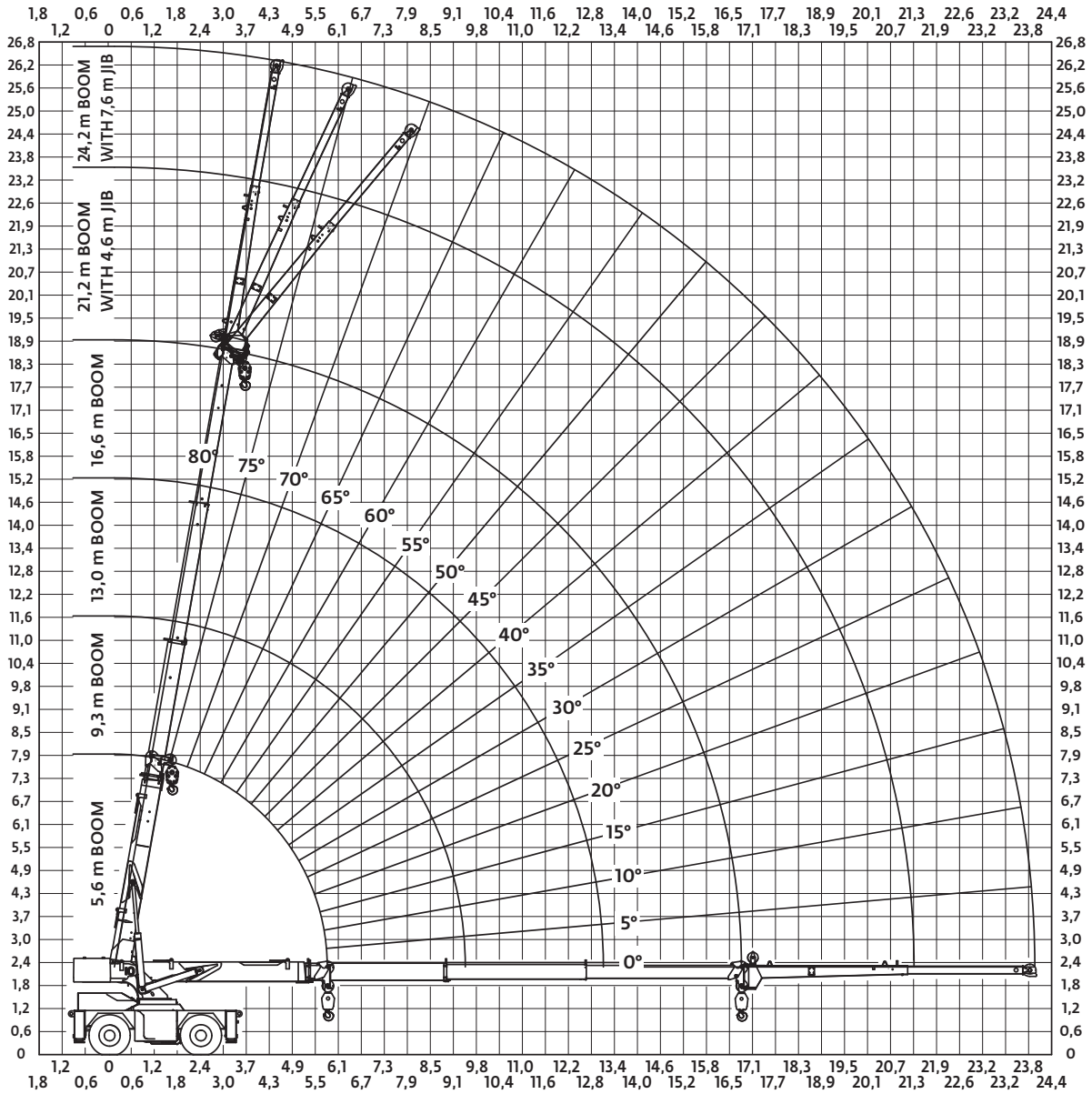

Height from the ground in meters

Operating radius in meters from axis of rotation

THIS CHART IS ONLY A GUIDE AND SHOULD NOT BE USED TO OPERATE THE CRANE.

The individual crane's load chart, operating instructions and other instructional plates must be read and understood prior to operating the crane.

Load chart

Metric 85%

MAIN BOOM LOAD RATINGS ON OUTRIGGERS								
Extended and Down 360° or Retracted and Down Front/Rear								
Radius (m)	5,6 m BOOM		9,3 m BOOM		13,0 m BOOM		16,6 m BOOM	
	Boom Angle (deg)	Rated Load (kg)	Boom Angle (deg)	Rated Load (kg)	Boom Angle (deg)	Rated Load (kg)	Boom Angle (deg)	Rated Load (kg)
2,0	63	18 000	74,5	10 875	—	—	—	—
2,4	58	15 350	71,5	10 875	78	10 725	—	—
3,0	50	13 650	67,5	10 875	75	9775	79	7620
3,7	38,5	12 200	62,5	10 875	71,5	9000	76,5	6960
4,3	24,5	10 375	58,5	10 875	69	8185	74,5	6395
4,6	0	8570	56	10 200	67,5	7820	73,5	6120
4,9	—	—	53,5	9525	66	7505	72,5	5895
5,5	—	—	49	8365	63	6915	70	5485
6,1	—	—	43,5	7390	60	6460	68	5100
6,7	—	—	37	6360	56,5	6030	65,5	4785
7,3	—	—	29,5	5560	53	5555	63	4505
7,9	—	—	19,5	4905	49,5	4905	61	4255
8,2	—	—	0	4610	47,5	4630	59,5	4135
8,5	—	—	—	—	46	4380	58,5	4025
9,1	—	—	—	—	41,5	3940	56	3820
9,8	—	—	—	—	36,5	3510	52,5	3625
10,4	—	—	—	—	31	3200	50	3300
11,0	—	—	—	—	25	2930	47	3020
11,6	—	—	—	—	15,5	2690	44	2780
11,9	—	—	—	—	0	2590	42,5	2670
12,2	—	—	—	—	—	—	40,5	2565
12,8	—	—	—	—	—	—	37	2370
13,4	—	—	—	—	—	—	33	2200
14,0	—	—	—	—	—	—	28,5	2045
14,6	—	—	—	—	—	—	23	1905
15,5	—	—	—	—	—	—	0	1715

MAIN BOOM LOAD RATINGS ON OUTRIGGERS								
Retracted and Down 360°								
Radius (m)	5,6 m BOOM		9,3 m BOOM		13,0 m BOOM		16,6 m BOOM	
	Boom Angle (deg)	Rated Load (kg)	Boom Angle (deg)	Rated Load (kg)	Boom Angle (deg)	Rated Load (kg)	Boom Angle (deg)	Rated Load (kg)
2,0	63	18 000	74,5	10 875	—	—	—	—
2,4	58	15 350	71,5	10 875	78	10 725	—	—
3,0	50	11 550	67,5	10 550	75	9695	79	7620
3,7	38,5	7955	62,5	7955	71,5	7430	76,5	6960
4,3	24,5	6150	58,5	6455	69	6145	74,5	5810
4,6	0	5550	56	5805	67,5	5635	73,5	5350
4,9	—	—	53,5	5255	66	5170	72,5	4950
5,5	—	—	49	4380	63	4330	70	4285
6,1	—	—	43,5	3715	60	3695	68	3755
6,7	—	—	37	3195	56,5	3200	65,5	3310
7,3	—	—	29,5	2780	53	2795	63	2900
7,9	—	—	19,5	2425	49,5	2460	61	2565
8,2	—	—	0	2270	47,5	2315	59,5	2420
8,5	—	—	—	—	46	2185	58,5	2285
9,1	—	—	—	—	41,5	1950	56	2045
9,8	—	—	—	—	36,5	1715	52,5	1805
10,4	—	—	—	—	31	1540	50	1625
11,0	—	—	—	—	25	1390	47	1470
11,6	—	—	—	—	15,5	1255	44	1335
11,9	—	—	—	—	0	1200	42,5	1270
12,2	—	—	—	—	—	—	40,5	1210
12,8	—	—	—	—	—	—	37	1100
13,4	—	—	—	—	—	—	33	1005
14,0	—	—	—	—	—	—	28,5	915
14,6	—	—	—	—	—	—	23	830
15,5	—	—	—	—	—	—	0	725

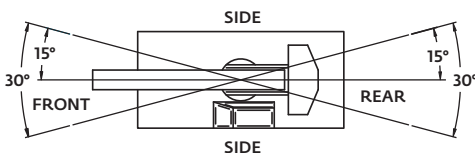

1) The rated loads are the maximum lift capacities as determined by operating radius, boom length and boom angle. The operating radius is the horizontal distance from a projection of the axis of rotation to the supporting surface, before loading, to the center of vertical hoist line or tackle with load applied.

2) The rated loads shown on outriggers do not exceed 85% of actual tipping. The rated loads shown on rubber do not exceed 75% of actual tipping. These ratings are based on freely suspended loads with the crane leveled, standing on a firm, uniform supporting surface. Practical working loads depend on supporting surface, operating radius and other factors affecting stability. Hazardous surroundings, climatic conditions, experience of personnel and proper training must all be taken into account by the operator.

3) The weights of all load handling devices such as hooks, hook blocks, slings, etc., except the hoist rope, shall be considered part of the load. See reduction chart.

4) Ratings on outriggers are for either outriggers fully extended and down or fully retracted and down. Ratings for outriggers fully retracted and down will apply for any intermediate outrigger setting.

5) Ratings on rubber depend on 12.00R20 tire capacity, condition of tires and proper inflation pressure (8,96 bar). Loads on rubber may be transported at a maximum speed of 4,0 km/h on a smooth, hard, level surface with boom retracted to the shortest length possible and centered over front. For 360° ratings on rubber, rear axle oscillation locks must be in place. Do not use jib with crane on rubber.

6) For operating radius not shown, use load rating of next larger radius.

7) The maximum deck load only is 9072 kg. Combined boom and deck loads are not permitted on rubber.

8) Do not induce any external side loads to boom or jib.

NOTES:
SHADED AREAS ARE GOVERNED BY STRUCTURAL STRENGTH, DO NOT RELY ON TIPPING.

OPERATION OF THIS EQUIPMENT IN EXCESS OF RATING CHARTS AND DISREGARD OF INSTRUCTIONS IS DANGEROUS AND Voids WARRANTY.

THIS CHART IS ONLY A GUIDE AND SHOULD NOT BE USED TO OPERATE THE CRANE.

The individual crane's load chart, operating instructions and other instructional plates must be read and understood prior to operating the crane.

Load chart

Metric 85%

4,6 m FIXED JIB CAPACITIES ON EXTENDED OUTRIGGERS (kg)					
Main Boom Angle (deg)	Jib Offset Angle				
	0 deg		15 deg		30 deg
	To 13,0 m Main Boom	To 16,6 m Main Boom	To 13,0 m Main Boom	To 16,6 m Main Boom	Any Boom Length
80	-	-	-	-	-
75	4215	2945	3355	2560	1585
70	3875	2765	3150	1970	1270
65	3605	2765	2945	1720	1065
60	3355	2560	2425	1585	975
55	3150	1970	2060	1270	860
50	2945	1720	1835	1065	790
45	2425	1585	1565	975	760
40	2060	1270	1495	860	700
35	1835	1065	1425	790	-
30	1565	975	1360	760	-
25	1495	860	1270	700	-
20	1425	790	-	-	-
15	1360	760	-	-	-
10	1270	700	-	-	-
5	-	-	-	-	-
0	-	-	-	-	-

4,6 m - 7,6 m TELE JIB CAPACITIES ON EXTENDED OUTRIGGERS (kg)										
Main Boom Angle (deg)	4,6 m Length					7,6 m Length				
	Jib Offset Angle					Jib Offset Angle				
	0 deg		15 deg		30 deg	0 deg		15 deg		30 deg
	To 13,0 m Main Boom	To 16,6 m Main Boom	To 13,0 m Main Boom	To 16,6 m Main Boom	Any Main Boom	To 13,0 m Main Boom	To 16,6 m Main Boom	To 13,0 m Main Boom	To 16,6 m Main Boom	Any Main Boom
80	3855	3875	2310	2160	1385	2640	2630	1680	1565	995
75	3170	3015	1995	1860	1195	2320	2200	1445	1345	855
70	2690	2530	1715	1605	1035	1960	1845	1240	1160	735
65	2310	2160	1480	1385	900	1680	1565	1065	995	640
60	1995	1860	1275	1195	790	1445	1345	915	855	555
55	1715	1605	1095	1035	705	1240	1160	785	735	490
50	1480	1385	945	900	645	1065	995	670	640	445
45	1275	1195	830	790	620	915	855	585	555	430
40	1095	1035	735	705	620	785	735	515	490	430
35	945	900	675	645	580	670	640	470	445	405
30	830	790	650	620	565	585	555	450	430	360
25	735	705	650	620	-	515	490	450	430	-
20	675	645	650	580	-	470	445	405	405	-
15	650	620	565	565	-	450	430	360	360	-
10	650	620	-	-	-	450	430	-	-	-
5	650	580	-	-	-	405	405	-	-	-
0	565	565	-	-	-	360	360	-	-	-

MAIN BOOM ON RUBBER		
Any Boom Length		
Radius (m)	Front Rating (kg)	360° Rating (kg)
2,0	6965	6735
2,4	6395	6145
3,0	5100	4895
3,7	4470	4025
4,3	3945	3365
4,6	3715	3080
4,9	3500	2880
5,5	3125	2670
6,1	2800	2300
6,7	2525	1980
7,3	2260	1705
7,9	2020	1470
8,2	1910	1365
8,5	1860	1275
9,1	1665	1220
9,8	1495	1170
10,4	1335	965
11,0	1195	855
11,6	1065	745
11,9	1005	695
12,2	980	640
12,8	955	590
13,4	865	530
14,0	780	465
14,6	700	405
15,5	590	330

NOTES:
JIB CAPACITY IS LIMITED BY BOTH STRUCTURAL CAPACITY CHART AND MAIN CAPACITY CHART.

SHADED AREAS ARE GOVERNED BY STRUCTURAL STRENGTH, DO NOT RELY ON TIPPING.

OPERATION OF THIS EQUIPMENT IN EXCESS OF RATING CHARTS AND DISREGARD OF INSTRUCTIONS IS DANGEROUS AND VOIDS WARRANTY.

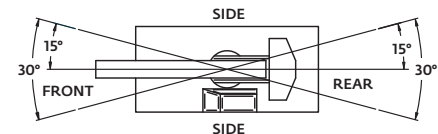

1) The rated loads are the maximum lift capacities as determined by operating radius, boom length and boom angle. The operating radius is the horizontal distance from a projection of the axis of rotation to the supporting surface, before loading, to the center of vertical hoist line or tackle with load applied.

2) The rated loads shown on outriggers do not exceed 85% of actual tipping. The rated loads shown on rubber do not exceed 75% of actual tipping. These ratings are based on freely suspended loads with the crane leveled, standing on a firm, uniform supporting surface. Practical working loads depend on supporting surface, operating radius and other factors affecting stability. Hazardous surroundings, climatic conditions, experience of personnel and proper training must all be taken into account by the operator.

3) The weights of all load handling devices such as hooks, hook blocks, slings, etc., except the hoist rope, shall be considered part of the load. See reduction chart.

4) Ratings on outriggers are for either outriggers fully extended and down or fully retracted and down. Ratings for outriggers fully retracted and down will apply for any intermediate outrigger setting.

5) Ratings on rubber depend on 12.00R20 tire capacity, condition of tires and proper inflation pressure (8,96 bar). Loads on rubber may be transported at a maximum speed of 4,0 km/h on a smooth, hard, level surface with boom retracted to the shortest length possible and centered over front. For 360° ratings on rubber, rear axle oscillation locks must be in place. Do not use jib with crane on rubber.



6) For operating radius not shown, use load rating of next larger radius.

7) The maximum deck load only is 9072 kg. Combined boom and deck loads are not permitted on rubber.

8) Do not induce any external side loads to boom or jib.

THIS CHART IS ONLY A GUIDE AND SHOULD NOT BE USED TO OPERATE THE CRANE.
The individual crane's load chart, operating instructions and other instructional plates must be read and understood prior to operating the crane.

Rigging chart

RIGGING CHART	
 1-PART 0-10,000lb	 4-PART 0-40,000lb
WIRE ROPE: 9/16" Diameter 6 X 19 Bright Minimum required breaking strength = 37,000 lb	

MAXIMUM PERMISSIBLE SINGLE LINE PULL = 10,000 lb

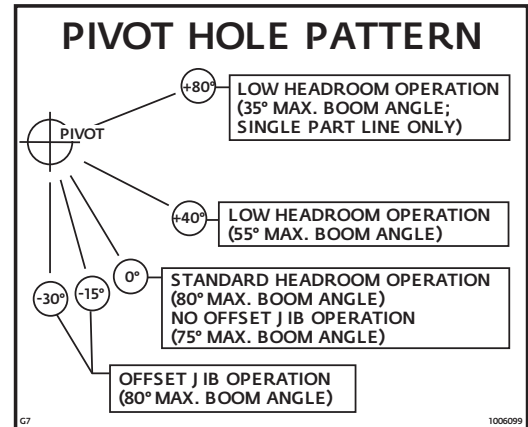

LOAD DISTRIBUTION CHART

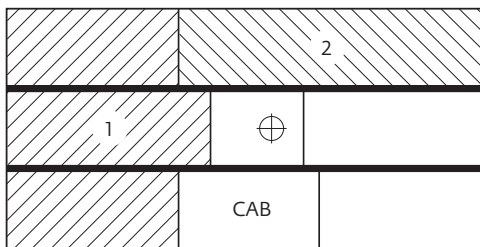

Maximum Allowable Uniformly Distributed Load

AREA 1	4,01 m ² (43.2 sq.ft.)	5985 kg (13,195 lb)
AREA 2	2,15 m ² (23.1 sq.ft.)	3087 kg (6805 lb)
TOTAL	6,16 m ² (66.3 sq.ft.)	9072 kg (20,000 lb)

1. Maximum travel speed with any or all loads - 4,0 km/h (2.5 MPH)
2. Loads to be transported on smooth level firm surfaces only.
3. Boom must be retracted and in center forward position.
4. Any combination or total of areas 1 and 2 may be used.
5. Lifting is not permitted when carry deck is loaded except for loading and unloading carry deck.
6. Rated pick and carry loads may be transported on deck area 1 provided the load is cribbed directly on the frame rails.

Rating reductions for load handling devices installed kg (lb)

	From main boom	From jib
Main block	161 kg (356 lb)*	Not applicable
Hook and ball	48 kg (105 lb)*	48 kg (105 lb)
Jib stowed	No reduction	Not applicable
4,6 m (15 ft) jib deployed	317 kg (700 lb)	No reduction
4,6 m - 7,6 m (15 ft - 25 ft) jib deployed	544 kg (1200 lb)	No reduction

*Refer to rating plate for actual weight

THIS CHART IS ONLY A GUIDE AND SHOULD NOT BE USED TO OPERATE THE CRANE.

The individual crane's load chart, operating instructions and other instructional plates must be read and understood prior to operating the crane.

Specifications

Superstructure



Boom

5,64 m – 16,61 m (18.5 ft – 54.5 ft) four-section full power boom.

Maximum tip height: 19,2 m (63 ft)



Optional boom extensions*

4,6 m (15 ft) fixed swingaway extension.

Maximum tip height: 23,1 m (76 ft)

4,6 m – 7,6 m (15 ft – 25 ft) telescopic swingaway extension.

Maximum tip height: 26,2 m (86 ft)

Both extensions can be offset 0°, -15°, and -30° via pivoting boom nose.



Boom nose

Two sheave, quick reeve type with three- pinned pivoting (0°, +40°, and +80°) design to minimize head space requirements. Lowers head height 40,5 cm (1.33 ft) when nose is pivoted fully forward.



Boom elevation

Two double acting hydraulic cylinders with integral holding valve. Elevation: 0° to 80°.



Anti-two block device

Standard anti-two block device (hard wired), which, when activated, provides an audible and visual warning to the operator and “locks out” all functions whose movement can cause two-blocking.



Rated Capacity Limiter (RCL)

Black and white, graphical display of boom angle, boom length, boom radius, rated load, and calculated load. Allows for operator inputs to set the crane configuration. RCL system is hardwired and calculates load via pressure transducers in the lift cylinder. Display includes a color coded light bar and audible alarm with function cut-out if load exceeds the load chart parameters.

*Optional RCL system includes a full color graphical display, work area definition (WADS), and a datalogger capable.



Swing

Ball bearing swing circle with 360° continuous rotation. Worm gear and pinion driven by hydraulic motor. Spring applied, hydraulic released brake. Equipped with swing enable control.

Maximum speed: 2.5 rpm



Hydraulic system

One pressure compensated variable displacement axial piston pump, with load sensing.

Maximum output of: 155 LPM (41.0 GPM)

Maximum operating pressure: 276 bars (4000 p.s.i.)

Six-section valve bank, chassis mounted, operated via dash mounted pilot pressure hydraulic joystick controllers.

151,4 L (40 gal) steel hydraulic reservoir with sight level gauge and steel side plating to guard against side impact.

Return line replaceable filter with by-pass protection and service indicator. Cartridge filter rating of three micron.



Hoist specifications

Smooth drum with cable follower.

Maximum hoist pull (first layer): 63,6 kN (14,300 lb)

Maximum permissible single line pull:
44,5 kN (10,000 lb.) (3.5:1 design factor)

Maximum single line speed: 64 m/min (210 fpm)

Rope construction: 6 x 19 XXIPS / IWRC

Rope diameter: 14 mm (9/16 in)

Rope length: 97,5 m (320 ft)

Carrier



Chassis

High strength alloy frame constructed with integral outrigger housings; front and rear lifting, tie-down, and towing lugs. 66.3 sq. ft. carrydeck size with 9072 kg (20,000 lb) deck only carrying capacity. Deck coated with anti-skid treatment.



Outriggers

Single stage hydraulic telescoping beam with oblique style jack cylinder on all four corners. Provides extended and down and retracted and down lifting capabilities. Integral holding valve on both beam and jack.

Outrigger positioning indicator located in dash display.

Outrigger pad size: 222 mm x 254 mm (8.75 in x 10 in)

Maximum outrigger pad load: 15 468 kg (34,100 lb)/ 401 p.s.i.



Outrigger controls

Independent outrigger control rocker switches for beam or jack selection with a separate extend /retract rocker selector switch. 360° level bubble located inside cab.



Engine (Tier IV)

Cummins QSB 3,3 L four cylinder / turbo-charged diesel rated at 75 kW (100 hp) at 2600 rpm. Includes standard 120V engine block heater and air intake “Grid” heater. Engine hour meter located in dash display. Alternator: 120 amp. Maximum Torque: 414 Nm (305 ft/lb). Fuel requirements: Maximum of 15 ppm sulphur content Requires “Ultra Low” diesel fuel.

NOTE: Tier IV required for sale in North America.



Engine (Tier III)

Cummins QSB 3.3L four cylinder / turbo-charged diesel rated at 74 kW (99 hp) at 2600 r.p.m. Includes std. 120V engine block heater and air intake “Grid” heater. Engine hour meter located in dash display. Alternator: 90 amp. Maximum Torque: 415 Nm (306 ft/lb).

NOTE: Required for sale outside of North America and European Union countries.



Fuel tank capacity

Steel with side impact plate. Capacity: 151,4L (40 gal).

*Denotes optional equipment

Carrier



Transmission

Powershift with four speeds forward and four reverse. Steering column mounted shifter.



Operators control station

Frame mounted, open air style control station with cab shell includes all crane functions and driving controls and equipped with overhead safety glass. Other standard equipment includes a suspension seat with seat belt, sight level bubble and 1,1 kg (2.5 lb) fire extinguisher, and tilt steering wheel. The dash panel will display the fuel level gauge, water temperature gauge, engine r.p.m., battery voltage, and hour meter. Indicator lights will display parking brake, low transmission pressure, low brake pressure, outrigger position, headlights, work lights (if ordered), and hoist 3rd wrap (if ordered). Crane function indicator and turn signal indicators are also included. The RCL display will be mounted on the top of the dash panel for direct line of sight for the operator.



*Operators control station enclosed

Includes the standard cab shell and all controls and indicators noted above, with the addition of front, rear, and right side glass, a split (two-piece) hinged door with sliding glass, front windshield wiper and washer, hot water heater and defroster with fan and cab dome light.



Electrical system

One heavy duty maintenance free 12V battery, 820CCA at 0°F.



Drive

Two-wheel (front-wheel) as standard with four-wheel drive as an option. Drive axles supplied with planetary hubs and limited slip differential.



Steer

Standard three steering modes.
Front (two-wheel), four-wheel coordinated, and four-wheel crab steer with electronic self alignment.
Three position rocker switch located on dash panel.

Outside Turning Radius:

Two wheel steer: 6,2 m (20 ft 4.8 in)

Four wheel steer: 3,9 m (13 ft 1 in)



Suspension/axles

Front: Drive / steer in both two-wheel drive and four-wheel drive
Rear: non-drive with steer in two-wheel drive, drive/steer in four-wheel drive.

Front axle is rigid mounted to frame. Rear axle offers 1.5° of oscillation.



Brakes

Hydraulic actuated internal wet-disc service brake acting on each drive wheel. Dash mounted rocker switch with indicator light for activating or release of the dry disc parking brake mounted on the transmission output yoke.



Tires

Tubeless type, semi-aggressive tread. 12.00 R20



Light

Full LED lighting includes turn indicators, head, tail, brake, and hazard warning lights recessed mounted.



Maximum speed

33,8 km/h (21.0 mph)



Gradeability (theoretical)

68% ... (to drive train stall) NO LOAD

40% ... (to drive train stall) with 9072 kg(20,000 lb) DECK LOAD

Gross vehicle weight (GVW)

16 494 kg (36,364 lb) basic unit with Tier IV engine.

Miscellaneous standard equipment

- Back-up motion alarm
- Outrigger motion alarm
- No-skid decking
- Front and rear lifting
- Towing
- Tie-down lugs
- Hoist third wrap indicator with hoist function cut-out
- Hoist drum rotation indicator

*Optional equipment

- Auxiliary lighting: includes cab mounted amber flashing light and dual base boom mounted LED work lights
- Convenience package: includes front and rear pintle hitch, dual rear view mirrors, head and tail light metal mesh grille covers
- Enclosed cab package: includes heater and defroster, cab dome light, all window glass, and two-piece split door
- Four-wheel drive
- Below deck hydraulic tow winch with 4536 kg (10,000 lb) capacity
- 4,6 m (15 ft) fixed boom extension
- 4,6 m – 7,6 m (15 ft – 25 ft) telescopic boom extension
- Air conditioning (closed cab option required)
- 360° swing lock

*Denotes optional equipment

Symbols glossary



Axles



Counterweight



Grade



Outriggers



Boom



Drive



Heavy duty jib



Radius



Boom elevation



Electrical system



Hoist



Rotation



Boom extension



Engine



Hookblock



Speed



Boom length



Extension



Hydraulic system



Steering



Boom nose



Frame



Lights



Suspension



Brakes



Fuel tank capacity



Oil



Swing



Cab



Gear



Outrigger controls



Tires



Transmission

Notes

Manitowoc Cranes

Regional headquarters

Americas

Manitowoc, Wisconsin, USA

Tel: +1 920 684 6621

Fax: +1 920 683 6277

Shady Grove, Pennsylvania, USA

Tel: +1 717 597 8121

Fax: +1 717 597 4062

Europe and Africa

Dardilly, France - TOWERS

Tel: +33 (0)4 72 18 20 20

Fax: +33 (0)4 72 18 20 00

Wilhelmshaven, Germany - MOBILE

Tel: +49 (0) 4421 294 0

Fax: +49 (0) 4421 294 4301

China

Shanghai, China

Tel: +86 21 6457 0066

Fax: +86 21 6457 4955

Middle East and Greater Asia-Pacific

Singapore

Tel: +65 6264 1188

Fax: +65 6862 4040

Dubai, UAE

Tel: +971 4 8862677

Fax: +971 4 8862678/79



This document is non-contractual. Constant improvement and engineering progress make it necessary that we reserve the right to make specification, equipment, and price changes without notice. Illustrations shown may include optional equipment and accessories and may not include all standard equipment.